

Article number: 20291140320R2SCR

Description: E+G Linear actuators - GN 291.1-40-320-R2-SCR

## Measures

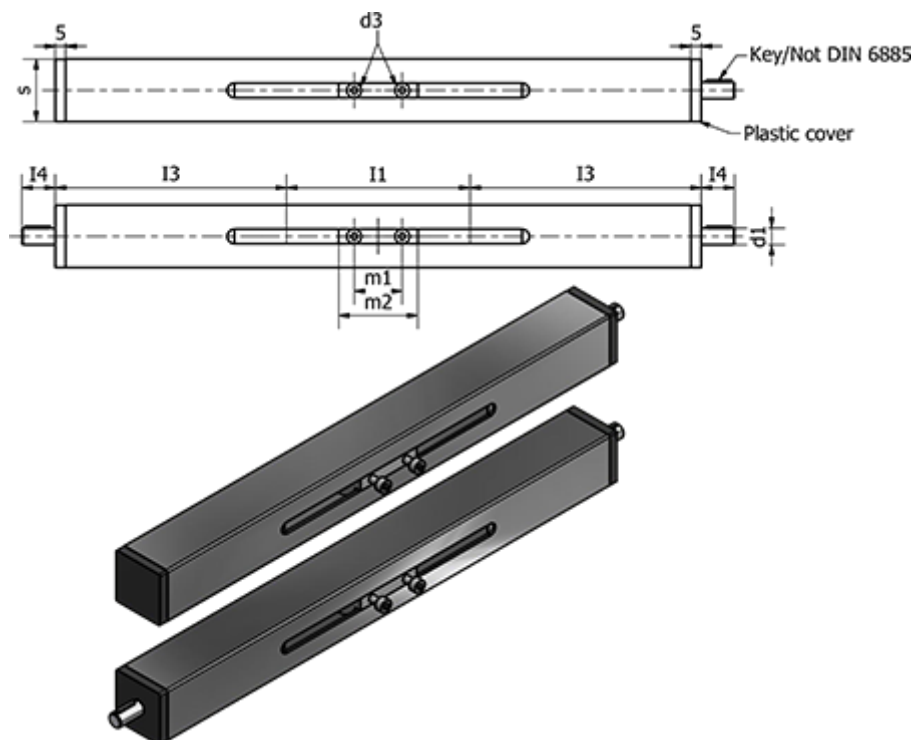

d1 f7 = 12

d2 = M5

I1 = 320

I2 = I2+240

I3 = 120

I4 = 17

m1 = 42

m2 = 54

Max. travel = 1570

s = 40

Shaft key DIN 6885 = A4x4x12

Shaft thread = TR20x4